

ACCESSORIES

VACB COUNTER MODEL GAS CHARBROILER



- CUTTING BOARD
- CONDIMENT RAIL
- PLATE RAIL
- BACKSPASH
- GRATE OPTIONS
- GRIDDLE PLATE

STANDARD FEATURES

- Stainless steel construction.
- Welded and smooth blended edges.
- Line matched to MSA,900RX griddles and VHP hotplate accessories.
- Cutting board accessory features stainless steel frame with removable board inserts. Inserts are 1" thick X 7" wide, Sani-TUFF® rubber NSF listed boards.
- Condiment rails will accommodate up to the following amounts of 1/6 size containers:
 - 25" model – 3
 - 36" model – 4
 - 47" model – 6
 - 60" model – 8
 - 72" model – 10
- Plate rails feature a full 12¼" deep stainless steel shelf.
- Back splash kit has 6" back and tapered sides.
- Variety of grate options available to fit your broiling needs. Grates are cast iron or welded standard steel construction.
- Griddle plate accessory is constructed of ¼" welded standard steel plate.
- One year limited parts and labor warranty.

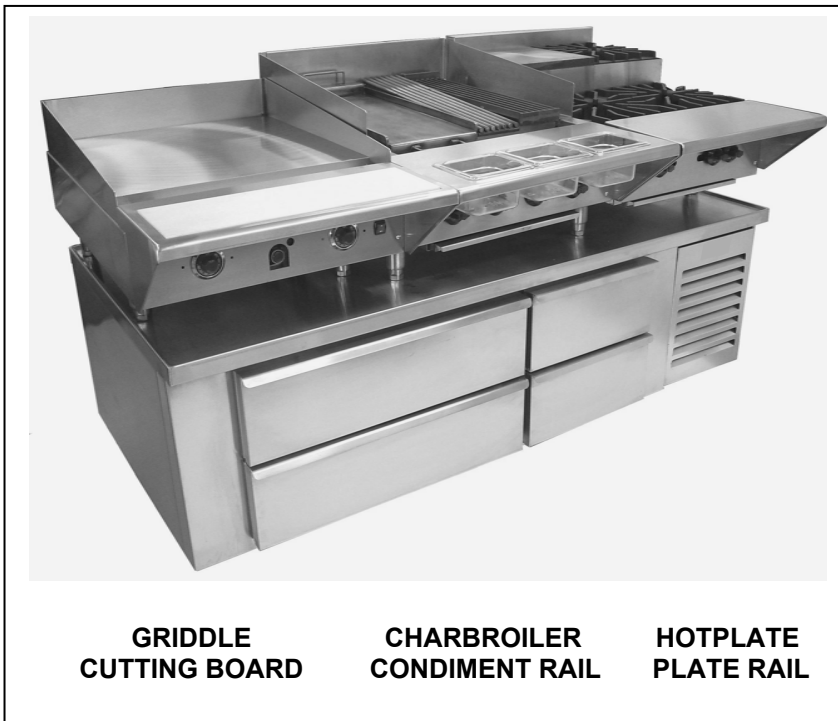

OPTIONS

- Product variations available. See your sales representative for product variance requests.

SPECIFY CHARBROILER SIZE WHEN ORDERING.

ACCESSORIES VACB COUNTER MODEL GAS CHARBROILER

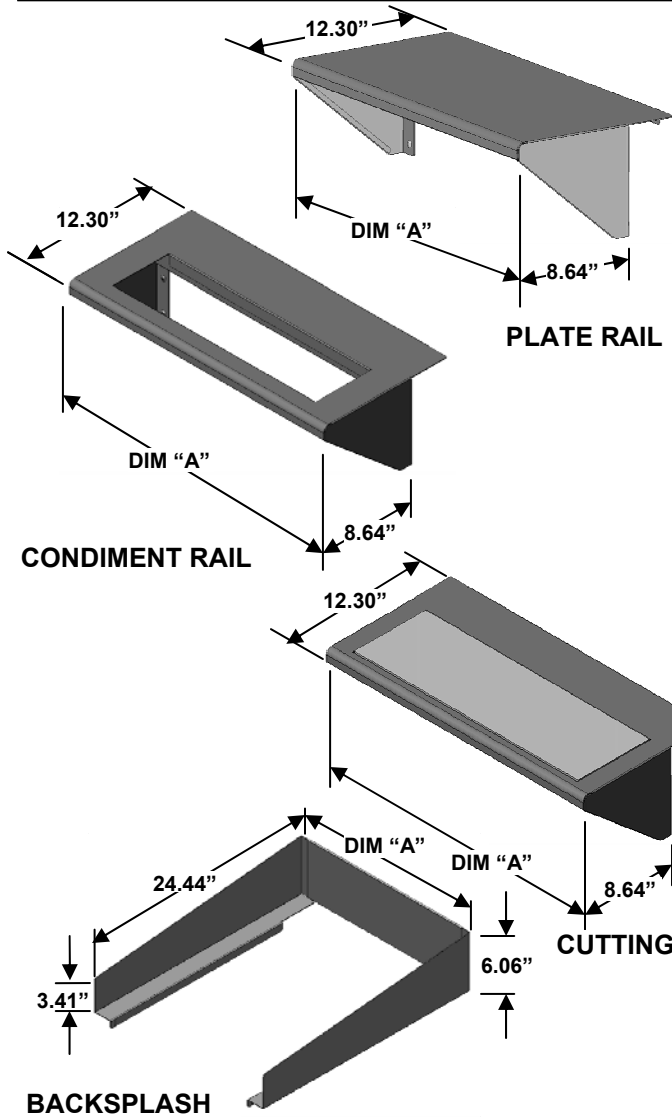

Dim "A" = 25.38", 36.13", 46.81", 60.63", 72.63"

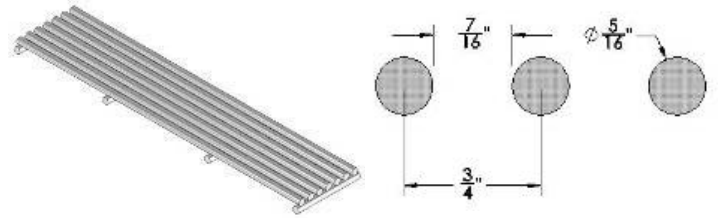

GRATE-RR724

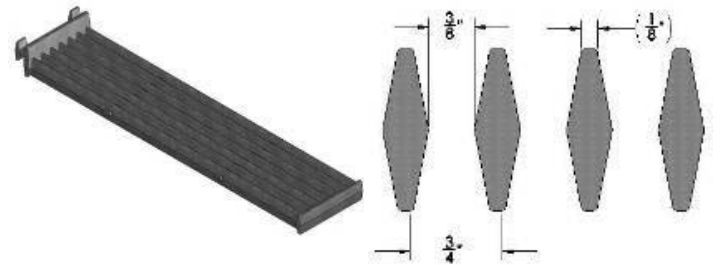

GRATE-CDIA24

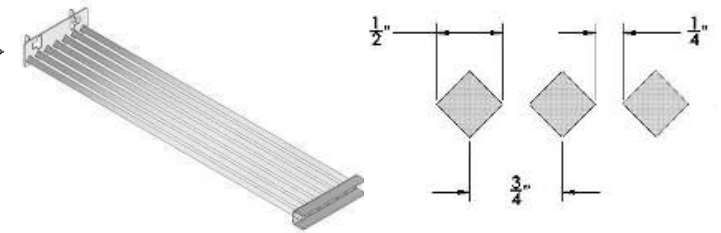

GRATE-DIA24

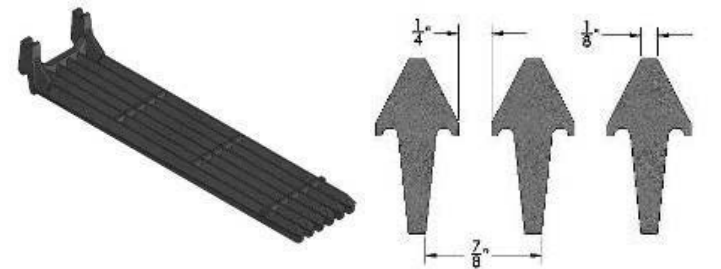

GRATE-CSTR24

All above grates are 5.25" wide X 24"

GRATES	
DESCRIPTION	ACCESSORY CODE
Round rod(1/2"welded steel rods)	GRATE-RR724
Cast diamond(standard-cast iron)	GRATE-CDIA24
Diamond fabricated(welded steel)	GRATE-DIA24
Cast straight(cast iron)	GRATE-CSTR24
Griddle Plate(welded 1/4" steel)	GRATE-GRID24

ACCESSORY CODES				
MODEL #	PLATE RAIL	CONDIMENT RAIL	CUTTING BOARD	BACK SPLASH
VACB20	PLTRAIL-ACB20	N/A	N/A	BCKSPLH-ACB20
VACB25	PLTRAIL-ACB25	CONRAIL-ACB25	CUTBD-ACB25	BCKSPLH-CB25
VACB36	PLTRAIL-ACB36	CONRAIL-ACB36	CUTBD-ACB36	BCKSPLH-CB36
VACB47	PLTRAIL-ACB47	CONRAIL-ACB47	CUTBD-ACB47	BCKSPLH-CB47
VACB60	PLTRAIL-ACB60	CONRAIL-ACB60	CUTBD-ACB60	BCKSPLH-CB60
VACB72	PLTRAIL-ACB72	CONRAIL-ACB72	CUTBD-ACB72	BCKSPLH-CB72

*Two piece board

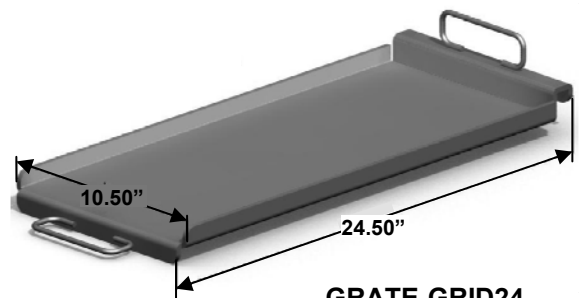

GRATE-GRID24

NOTE: In line with its policy to continually improve its products, Vulcan-Hart Company reserves the right to change materials and specifications without notice.