

Item# _____
Project: _____
Qty: _____

Hand Sink



HS10-CWP Shown

Features

- 304 Series Stainless Steel
- 18 Gauge Construction
- 7³/₄" Backsplash
- 4" Gooseneck Faucet with Wrist Blade Handles
- 1¹/₂" Basket Strainer and Mounting Bracket Included

Serv-Ware



Serv-Ware
www.servware.com

Phone:(800).768.5953

Fax:(800).976.1299

Revised 4/19



Item# _____

Project: _____

Qty: _____

Hand Sink

HS10-CWP

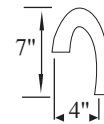
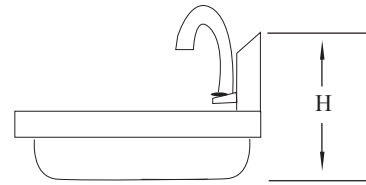
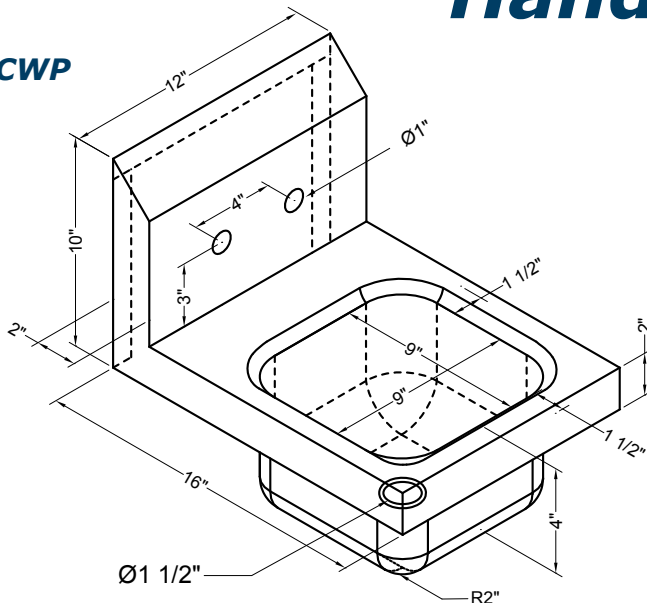

HS15-CWP

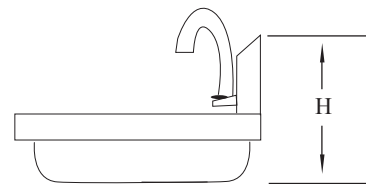
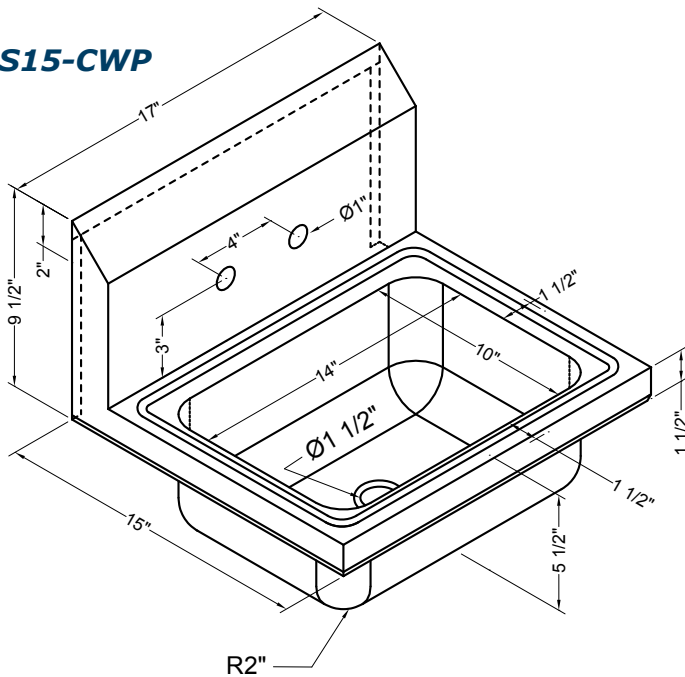

Serv-Ware

Model

Bowl Size

Size

Weight/lbs

(W x D x H)

(W x D x H)

(Shipping)

HS10-CWP

9" x 9" x 4"

12" x 16" x 12.5"

10

HS15-CWP

14" x 10" x 5.5"

17" x 15" x 13.5"

15

HS15-CWP-SS

Wallmount Sidesplash Optional



Serv-Ware
www.servware.com

Phone: (800).768.5953

Fax: (800).976.1299

Revised 4/19

