



POT & PAN CHEMICAL SANITIZING CORNER DISHWASHER

S-C

Scullery
Low Temperature
Dishmachine



FEATURES

- 40 racks / 160 covers per hour.
- All stainless steel construction assures long life and years of trouble free operation.
- Unique spray arm system features upper and lower stainless steel wash arms with reinforced end caps. Specially designed pull-pins allow wash arms to be easily removed for cleaning.
- Pump purging system improves results by eliminating soil and chemical carryover during rinse cycle.
- Top mounted controls include built-in chemical pumps and delimiting system that assures proper chemical usage.
- Auto start/stop makes operation safe and easy.
- Large 27" high door opening accommodates larger items and utensils.
- Integrated scrap tray prevents food soil from entering drain system.
- Stainless steel impeller offers extended life and service.
- Built-in strainer in water inlet to prevent water valve from clogging.

CMA MODEL: S-C

AVAILABLE OPTIONS



Temp-Sure
(Self contained 12kW heater)

Temp-Sure™ heater assures a continuous supply of 140° F hot water that guarantees excellent results.



Universal Slant Shelf
27"-42"

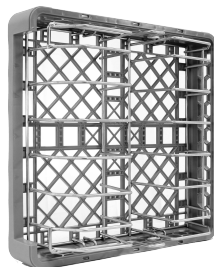

Sheet Pan Rack

- Solid/Powder Dual Bowl Dispenser
- Low Chemical Alarm
- Stainless Steel Dishtables
- Alternative Cycle Times
- Alternative Electrical Available for Export
- Stainless Steel Scrap Trap in lieu of Poly Pro

**CMA
MIZER®**
Registered Trademark





S-C
Chemical Sanitizing
Pot & Pan Single Rack
Dishwasher

WARNINGS:

- Plumbing connections must be made by a qualified service company who will comply with all available Federal, State, and Local Health, Plumbing and Safety codes.
- CMA recommends utilizing a water softening system to maintain water hardness measurements of 3.5 gpg (grains per gallon) or less. This will assure maximum results and optimum operation of the dishwasher.

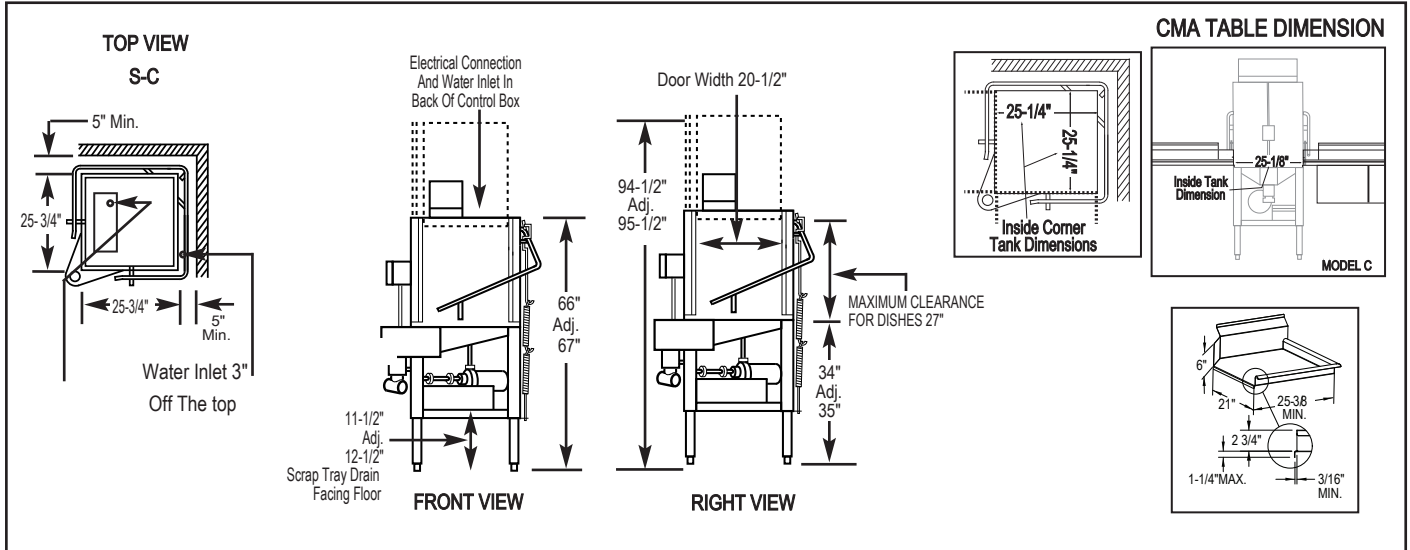

Specifications:

MODEL S-C	USA	METRIC		USA	METRIC
OPERATING CAPACITY RACKS PER HOUR (NSF RATED)	40	40	WASH PUMP MOTORS HP	1	1
OPERATING CYCLE WASH TIME-SEC RINSE TIME-SEC DWELL TIME-SEC TOTAL CYCLE TIME	45 30 15 90	45 30 15 90	DIMENSIONS DEPTH WIDTH (OUTSIDE DIMENSION) HEIGHT STANDARD TABLE HEIGHT MAXIMUM CLEARANCE FOR DISHES DRAIN CONNECTION (OFF FLOOR)	25-3/4" 25-3/4" 66"-67" 34" 27" 11-1/2"-12-1/2"	(65.4cm) (65.4cm) (168-170cm) (86cm) (68.5cm) (29.2cm-31.7cm)
WASH TANK CAPACITY	1.7 GAL.	(6.43 L)	STANDARD DISHRACK DIMENSIONS	1 20" x 20"	1 (50.8 X 50.8cm)
PUMP CAPACITY	68 GPM	(257 LPM)	ELECTRICAL RATING	VOLTS 115	AMPS 16
OPERATING TEMPERATURE REQUIRED RECOMMENDED	120°F 140°F	(49°C) (60°C)	APPROXIMATE SHIPPING WEIGHT	299#	(135.6kg)
WATER CONSUMPTION PER RACK PER HOUR	1.7 GAL. 68 GPH	(6.43 L) (257.4 LPH)	SHIPPING DIMENSIONS	PALLET & BOX @ 41" X 41" X 80"	
WATER REQUIREMENTS WATER INLET DRAIN-I.P.S.	3/4" 2"	(1.9cm) (5.1cm)			

Summary Specifications: Model S-C

CMA Energy Miser model S-C low temperature, chemical sanitizing commercial dishwasher meets NSF and UL sanitation and construction standards WITHOUT the use of BOOSTER or TANK HEATERS. The model S-C is constructed entirely of stainless steel. Each unit automatically washes, rinses and sanitizes food service utensils in standard 19-3/4" x 19-3/4" racks and accommodates oversized plates and utensils with a 27" high door clearance. Unit comes standard with upper and lower stainless steel wash arms. The model S-C incorporates a pump purging system that improves results by eliminating soil and chemical carryover during rinse cycle. **Note: This machine does not have built-in heaters, therefore produces no steam.**

Available Models: ■ S-AH Straight ■ S-C Corner ■ S-B

Advisory: CMA does NOT endorse "Tankless On-Demand" water heaters for use on CMA Dishmachine products. CMA DOES endorse, and highly recommends, the standard "tank" style water heaters, sized properly to handle each particular facility with their water heating requirements.



CMA Dishmachines 12700 Knott Street Garden Grove, CA 92841 • 800-854-6417 • 714-898-8781 • Fax: 714-895-2141 • www.cmadishmachines.com

CMA reserves the right to modify specifications or discontinue models without prior notification.

© 3-2020 CMA, Inc.

an Ali Group Company



The Spirit of Excellence