



**John
BOOS**
Since 1887

ITEM #: _____ QTY: _____
MODEL #: _____
PROJECT NAME: _____

123019

3601 S. Banker St. Effingham, IL 62401 • P.O. BOX 609 • Ph: (888) 431-2667 • Fax: (800) 433-2667

"41PB-2D" PRO-BOWL COMPARTMENT SINKS 14GA

1 COMPARTMENT WITH 2 DRAIN BOARDS - STAINLESS STEEL BASE



FEATURES:

- STANDARD 14GA TYPE 300 STAINLESS STEEL WITH #4 POLISH, SATIN FINISH
- 12" & 14" DEEP BOWLS
- ALL CORNERS, BOTH VERTICAL AND HORIZONTAL, COVERED AT 5/8" RADIUS
- BOTTOMS OF BOWLS FORMED FOR DRAINAGE TO 3-1/2" DIAMETER DIE STAMPED OPENING
- FULL LENGTH **10" HIGH BOXED BACKSPLASH**, WITH 2" RETURN TO WALL AT 45 DEGREE AND 3/4" TURNED DOWN REAR LIP
- 8" ON-CENTER, 1" FAUCET HOLES IN BACKSPLASH
- SOLID STAINLESS STEEL FRONT PANEL, TYPE 300 STAINLESS STEEL WITH #4 POLISH, SATIN FINISH
- ALL OUTSIDE CORNERS OF ASSEMBLY ARE BULLNOSED TO PROVIDE SAFE, CLEAN, AND POLISHED EDGE

CONSTRUCTION:

- TOP: STAINLESS STEEL SINKS ARE TIG WELDED, EXPOSED WELDS ARE POLISHED TO MATCH ADJACENT SURFACE
- BASE: STAINLESS STEEL BASES, STANDARD K.D.

MATERIAL:

- BOWLS & TOP: 14GA TYPE 300 STAINLESS STEEL WITH #4 POLISH, SATIN FINISH
- LEGS: 1-5/8" ROUND O.D. STAINLESS STEEL
- BRACING: 1-1/4" ROUND O.D. STAINLESS STEEL
- GUSSETS: STAINLESS STEEL
- FEET: 1" ADJUSTABLE STAINLESS STEEL BULLET FEET



14GA - "41PB-2D" PRO-BOWL SERIES SINK

12" DEEP	QTY	14" DEEP	QTY
41PB1618-2D18		41PB16184-2D18	
41PB1618-2D24		41PB16184-2D24	
41PB1620-2D18		41PB16204-2D18	
41PB1620-2D24		41PB16204-2D24	
41PB18-2D18		41PB184-2D18	
41PB18-2D24		41PB184-2D24	
41PB18-2D30		41PB184-2D30	
41PB1824-2D18		41PB18244-2D18	
41PB1824-2D24		41PB18244-2D24	
41PB1824-2D30		41PB18244-2D30	
41PB20-2D18		41PB204-2D18	
41PB20-2D24		41PB204-2D24	
41PB20-2D30		41PB204-2D30	
41PB24-2D24		41PB244-2D24	
41PB24-2D30		41PB244-2D30	
41PB3024-2D30		41PB30244-2D30	
41PB3024-2D36		41PB30244-2D36	

OPTIONAL ACCESSORIES

DESCRIPTION	QTY
END SPLASHES, R, L, OR BOTH	
FAUCETS	
ADD-A-FAUCETS	
PRE-RINSE UNITS	
LEVEL WASTE	
OVERSHELVES	
POT RACK	

DETAILED SPECIFICATIONS

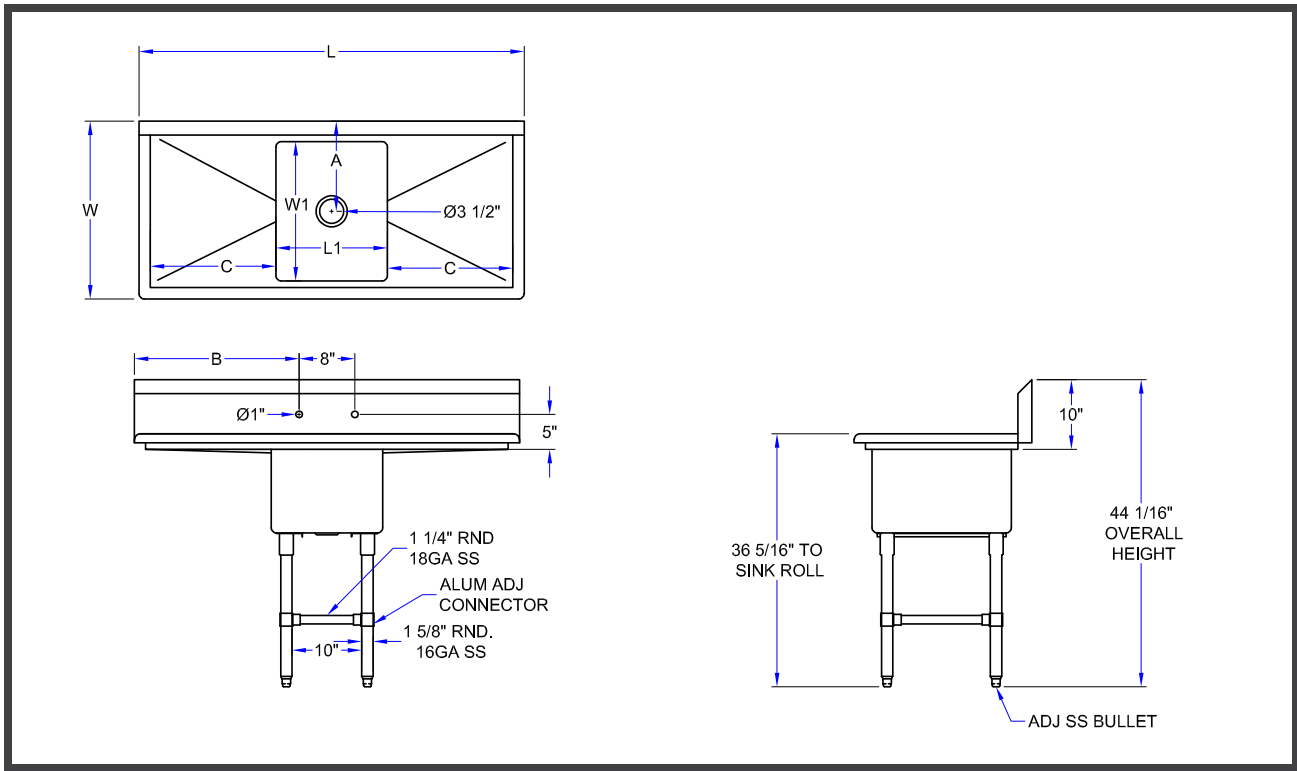

14GA - "41PB-2D" PRO-BOWL SERIES SINK

12" DEEP	14" DEEP	L	W	L1	W1	A	B	C
41PB1618-2D18	41PB16184-2D18	55-1/4"	23-1/2"	16"	18"	11-15/16"	23-5/8"	18"
41PB1618-2D24	41PB16184-2D24	67-1/4"	23-1/2"	16"	18"	11-15/16"	29-5/8"	24"
41PB1620-2D18	41PB16204-2D18	55-1/4"	25-1/2"	16"	20"	12-15/16"	23-5/8"	18"
41PB1620-2D24	41PB16204-2D24	67-1/4"	25-1/2"	16"	20"	12-15/16"	29-5/8"	24"
41PB18-2D18	41PB184-2D18	57-1/4"	23-1/2"	18"	18"	11-15/16"	24-5/8"	18"
41PB18-2D24	41PB184-2D24	69-1/4"	23-1/2"	18"	18"	11-15/16"	30-5/8"	24"
41PB18-2D30	41PB184-2D30	81-1/4"	23-1/2"	18"	18"	11-15/16"	36-5/8"	30"
41PB1824-2D18	41PB18244-2D18	57-1/4"	29-1/2"	18"	24"	14-15/16"	24-5/8"	18"
41PB1824-2D24	41PB18244-2D24	69-1/4"	29-1/2"	18"	24"	14-15/16"	30-5/8"	24"
41PB1824-2D30	41PB18244-2D30	81-1/4"	29-1/2"	18"	24"	14-15/16"	36-5/8"	30"
41PB20-2D18	41PB204-2D18	42-3/16"	25-1/2"	20"	20"	12-15/16"	8-9/16"	18"
41PB20-2D24	41PB204-2D24	48-3/16"	25-1/2"	20"	20"	12-15/16"	8-9/16"	24"
41PB20-2D30	41PB204-2D30	54-3/16"	25-1/2"	20"	20"	12-15/16"	8-9/16"	30"
41PB24-2D24	41PB244-2D24	75-1/4"	29-1/2"	24"	24"	14-15/16"	33-5/8"	24"
41PB24-2D30	41PB244-2D30	87-1/4"	29-1/2"	24"	24"	14-15/16"	39-5/8"	30"
41PB3024-2D30	41PB30244-2D30	93-1/4"	29-1/2"	30"	24"	14-15/16"	42-5/8"	30"
41PB3024-2D36	41PB30244-2D36	105-1/4"	29-1/2"	30"	24"	14-15/16"	48-5/8"	36"

SOME UNITS SHIP UNASSEMBLED FOR REDUCED SHIPPING COST. ALL DIMENSIONS ARE TYPICAL. TOLERANCE +/- .500"

John Boos & Co. is constantly engaged in a program of improving products and therefore reserves the right to change specifications without prior notice.



3601 S. Banker St. • Effingham, IL 62401 • PO BOX 609 • quotes@johnboos.com

123019



www.johnboos.com

666