



## Toaster

Eurodib's conveyor toaster have a capacity of 600 slices per hour. It comes with a heavy duty gear box and chain drive system and is built to manage high volume toasting. The unit is heated by dual robust metal incolony heating elements and the adjustable controls allow the operators to vary the amount of toasting. The unit can be adapted for pass through or return operation and has a large opening that makes it suitable for bagels and muffins.

## Product Features

- Stainless steel construction
- Top and bottom metal heating elements
- Dual function energy and speed performance control
- 3 function heat control
  - Dual top and bottom element heating
  - Top element heating
  - ECO energy saving feature
- Variable speed control of the conveyor belt
- Pass through and return operation
- Removable feeder rack and crumb tray
- Removable crumb/grease tray
- Large cavity opening for bagels, muffins: 2.2"
- Non slip adjustable legs



## Conveyor Toaster



SFE02710

# Conveyor Toaster

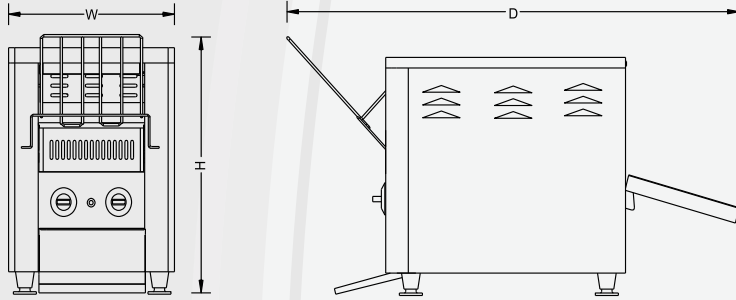
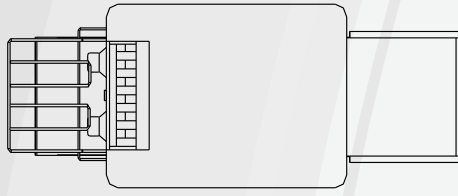

Product Code	Capacity/ Cooking Area	Electrical	Slice/ per hour	Product Overall Dimensions (inch)		
				Width	Depth	Height
<b>SFE02710</b>	10.2" x 15.7" x 2.7"	208V, 2000W, 9.6A, 6-15P	600 slices	14.6	29.5	15



SFE02710

■ Warranty: 1 year Parts and Labor



US 156 Lawrence Paquette, Champlain, NY 12919 | CAN 120 rue de la Barre, Boucherville, QC J4B 2X7  
1 888 956 6866 | info@eurodib.com | www.eurodib.com