

24" DEEP GLASS DOOR BACK BAR COOLER

Project Name: _____

Project Location: _____

Model #: _____ Quantity: _____

Available Warehouse: _____

EBB Series Model: EBB69G-24



Refrigeration System

- Side mounted, self-contained and fully detachable Blizzard R290 condensing unit uses environmentally friendly, EPA-compliant R290 refrigerant with zero (0) Ozone Depletion Potential (ODP) and three (3) Global Warming Potential (GWP). Blizzard R290 is easily replaceable and requires no on-site brazing.
- Electronically commutated (ECM) fan motors achieve rapid cooling with less energy consumption.
- Full-length air duct system ensures optimal circulation of cold air.
- Time-initiated and temperature-terminated auto defrost cycle for seamless operation.
- Large capacity, corrosion-resistant condenser and evaporator coils.
- Self-maintaining, energy-efficient condensate drain pan requires no external drains or electric heaters.
- High performance, auto-reverse condenser fan motor supports compressor ventilation and condenser coil cleaning. Refer to owner's manual for full maintenance instructions.
- Pre-wired and ready to plug, 115V/60Hz/1Ph, NEMA 5-15P.

Cabinet Construction

- Heavy duty stainless steel countertop with textured laminate, black vinyl exterior.
- Open spaced interior with no walls between compartments.
- Galvanized steel interior walls and high quality stainless steel floor.
- 1 3/4" thick high density polyurethane insulation.
- Built-in caster thread receptacles for all models.

Lighting

- Shielded LED bar lighting with on/off switch provides bright, high color illumination at lower heat output.

Doors

- Low emissivity double glass panes reflect UV rays for efficient cooling.
- Black PVC door frames.
- Snap-in magnetic door gasket make cleaning and replacement an easy process.
- High strength, die-cast door handles.
- Pre-installed door locks keep your items safe from theft.

Shelving

- Two epoxy coated, steel wire shelves per section.
- Height adjustable stainless steel clips.

Temperature Control

- Multi-function digital controller with easy to read LED display.
- Factory preset temperature, 35°F.
- Temperature setting range from 33°F to 54°F.
- Audible overheat protection alarm for compressor and condenser coil.

Options

- Additional shelving.
- 3" or 5" swivel casters with locks.
- 3.5" – 6" height-adjustable and interchangeable legs.

 **Operating temperature range is 33°F ~ 54°F**



5 YEAR Compressor
3 YEAR Parts & Labor



Please visit our website for updated Energy Efficiency information

Ref/ Frz/Dual	Doors	Capacity			Shelves	Refrigerant	HP	Power V-Hz-Ph	Amps	Crated Weight	Exterior Dimensions		
		Cu. Ft.	12 oz. Cans	12 oz. Bottle							L	D	H*
REF	2	20	700	441	4	R-290	1/4+	115-60-1	2.5	328 lbs (149kg)	68" (1727mm)	24.5" (622mm)	37.25" (946mm)

(†) Based on evaporating temperature of 23°F (-5°C) & condensing temperature of 131°F (55°C). (►) Product capacity is calculated based on standard industry figures. (✳) Reference plan view for clarification on caster/unit height. If dimensions and capacity are critical, please contact Everest Refrigeration. Blizzard R290 replacement is at the sole discretion of Everest Refrigeration. Specifications subject to change without notice.

24" DEEP GLASS DOOR BACK BAR COOLER

EBB Series Model: EBB69G-24

DIMENSIONAL DATA

External Dimensions	L	68" (1727mm)
	D	24.5" (622mm)
	H*	37.25" (946mm)
Crated Weight	328 lbs. (149kg)	
Doors/Drawers/Lids	2	
Max Weight Support (LBS)	-	

STORAGE DATA

Net Capacity Cu. Ft. ▶	20
Shelves	4
Barrels	-
20 oz. Bottles	-
12 oz. Bottles	441
12 oz. Cans	700
8" Mugs	-
# of Pans (Top)	-
# of Pans (Drawer)	-
Dividers	-
Trays	-

ELECTRICAL DATA

Voltage	115-60-1
Full Load Amperage	2.5A
Feed Wires with Ground	3
Cord Length	9ft
NEMA Plug Type	 NEMA 5-15P

REFRIGERATION DATA

Compressor Mounting	Side
Refrigerant	R-290
Compressor HP	1/4+
BTU/HR †	1926

KEY

D	Door	R	Refrigerator
L	Lid	REF	Refrigerator
H	Half Door	F	Freezer
FD	Full Door	FRZ	Freezer
SD	Solid Door	DUAL	REF/FRZ Combo
GD	Glass Door	DR	Drawer

	Elevation	Right	Plan	3D	Back

PLAN VIEW

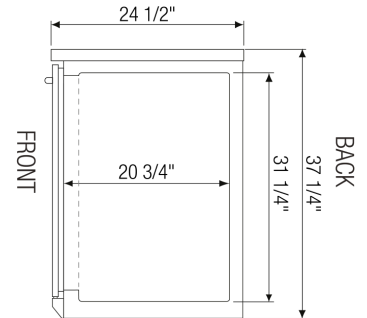
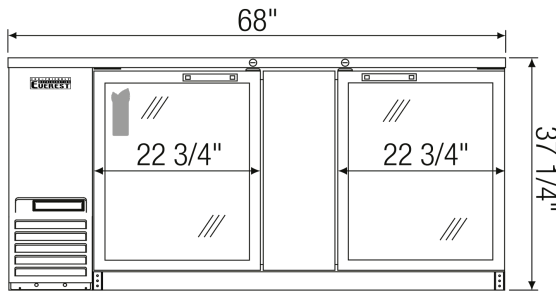

FRONT

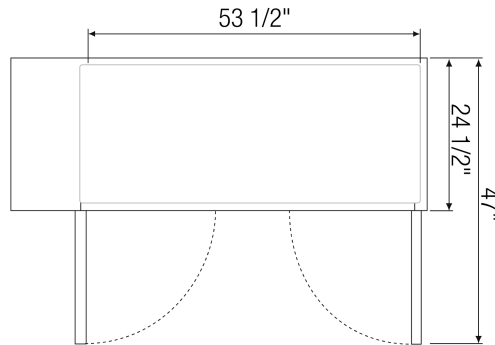

SIDE

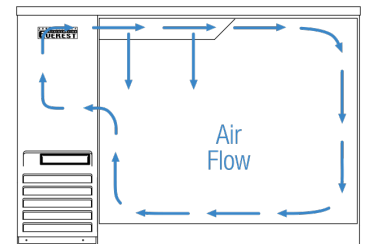

TOP

AIRFLOW

ACCESSORIES & OPTIONS

Part Number	Description
Additional Shelving	Contact Everest Refrigeration for more information.
AJL03-00	Interchangeable Leg for Caster
CASA3-01	3" Overall Height Caster Assembly - (2) Front (2) Rear
CASA5-01	5" Overall Height Caster Assembly - (2) Front (2) Rear

(†)Based on evaporating temperature of 23°F (-5°C) & condensing temperature of 131°F (55°C). (▶) Product capacity is calculated based on standard industry figures. (✖) Reference plan view for clarification on caster/unit height. If dimensions and capacity are critical, please contact Everest Refrigeration. Blizzard R290 replacement is at the sole discretion of Everest Refrigeration. Specifications subject to change without notice.