

DESIGNER LINE UNDERCOUNTER REFRIGERATOR

Model: D60N-U

Natural Refrigerant R-290 Model

Designer Line

60" Undercounter Refrigerator with Solid Doors



ENERGY STAR® Qualified Commercial Refrigerator

Stainless steel front, top, end panels and interior, aluminum back.



Options and Accessories

(upcharge and lead times may apply)

Stainless steel back	Expansion valve system
Add'l epoxy-coated steel shelves	Door locks
Stainless steel shelves	Special electrical requirements (consult factory)

Consult factory for other model configurations, options and accessories.

Project Name:

Model Specified:

Location:

Item No:

Quantity:

AIA #:

SIS #:

Standard Model Features

REFRIGERATION SYSTEM

- Performance-rated refrigeration system
- Natural, environmentally-safe, high-efficiency R-290 refrigerant¹
- Automatic, hot gas condensate evaporator
- Non-corrosive, plasticized fin evaporator coil
- Easily serviceable, back mounted compressor

CABINET ARCHITECTURE

- 2" non-CFC polyurethane foam insulation
- Smooth, polished chrome door handles
- Spring loaded, self closing doors
- Magnetic snap-in door gaskets
- Heavy-duty, epoxy-coated steel shelves
- Completely enclosed, vented and removable case back
- 1 3/8" diameter plate casters (factory installed)

MODEL FEATURES

- Electronic controller w/digital display & hi-low alarm
- Field rehingeable doors
- 2" high, bottom mounted front breather air divider

¹ R-290 refrigerant meets all federal and state regulatory requirements.

Continental
Refrigerator

Toll-Free: 800-523-7138
Phone: 215-244-1400
Fax: 215-244-9579

539 Dunksferry Road
Bensalem, PA 19020
www.continentalrefrigerator.com

APPROVAL:

Model Specifications

DIMENSIONAL DATA

Net Capacity (cu. ft.)	17.0 (481 cu l)
Width, Overall (in.)	60 (1524 mm)
Depth, Overall (in.) (incl. handles & bumpers)	32 3/16 (818 mm)
Height, Overall (in.) (incl. 1 3/8" plate casters)	31 13/16 (808 mm)
Shelf Area (sq. ft.)	8.1 (.8 sq m)
No. of Shelves	2
No. of Doors	2
Interior Depth (in.)	See Drawing
Interior Height (in.)	26 1/4 (667 mm)
Interior Width (in.)	56 (1422 mm)

REFRIGERANT DATA

Condensing Unit Size (H.P.)	1/5
Capacity (BTU/Hr)*	1625

ELECTRICAL DATA

Voltage (int'l)	115/60/1 (220/50/1)
Total Amps (int'l)	2.46 (1.85)
10 ft. Cord/Plug [attached] (int'l)	Yes (No)

SHIPPING DATA

Weight (lbs.)	315 (143 kg)
Height - Crated (in.)	43 1/4 (1099 mm)
Width - Crated (in.)	68 (1727 mm)
Depth - Crated (in.)	37 1/4 (946 mm)

* Rating @ +25°F evaporator, 90°F ambient

Figures in parentheses reflect metric equivalents rounded to the nearest whole unit.



Equipped with one NEMA-5-15P Plug
(varies by country)

Model Plan Views

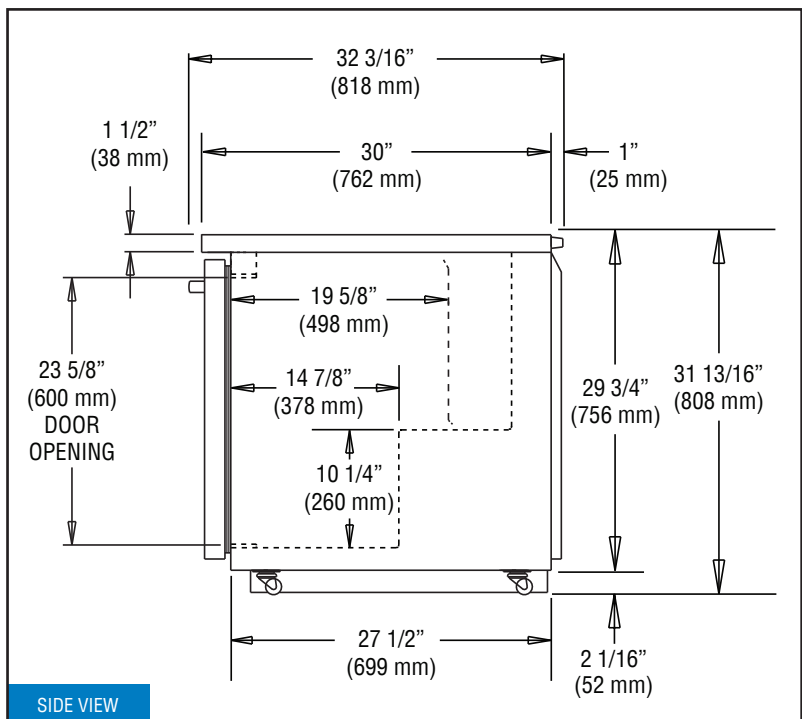
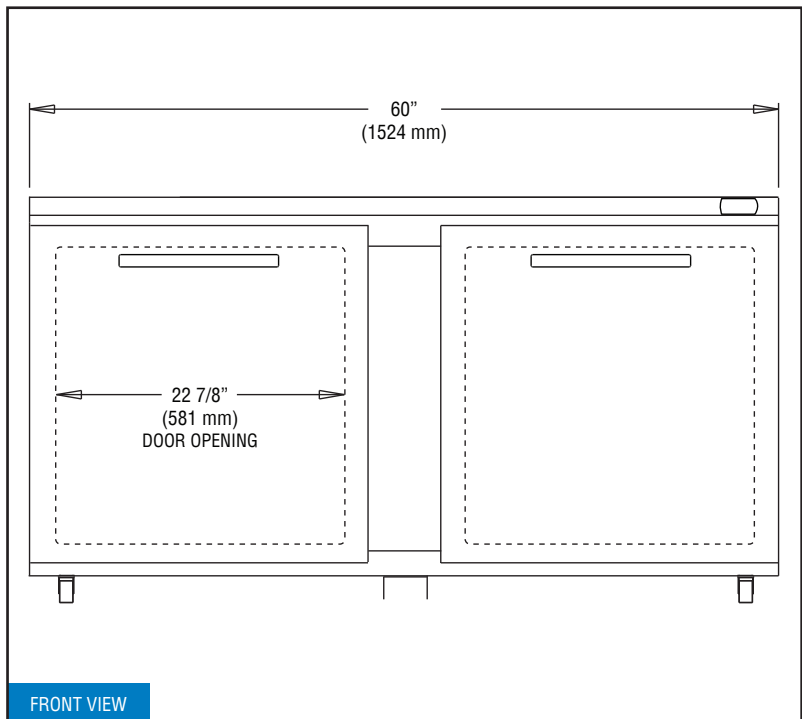

NOTE: For proper operation, the area under and in front of the cabinet **must** not be obstructed in any way.

Continental
Refrigerator

Toll-Free: 800-523-7138
Phone: 215-244-1400
Fax: 215-244-9579

539 Dunkserry Road
Bensalem, PA 19020
www.continentalrefrigerator.com

Due to our continued efforts in developing innovative products, specifications subject to change without notice.



MADE IN THE U.S.A.

© Copyright 2019, Continental Refrigerator.
A Division of National Refrigeration & Air Conditioning Products, Inc.