

BACK BAR EQUIPMENT

Model: **KC79SN**

Natural Refrigerant R-290 Model

79" Keg Cooler - Shallow Depth

Textured baked black enamel finish exterior, stainless steel countertop, interior back and side panels with reinforced stainless steel floor.



Options and Accessories

(upcharge and lead times may apply)

Epoxy-coated or stainless steel shelves	Faucet lock
Glass doors in lieu of solid doors	Riser base* (field installed)
Food storage rated stainless steel interior (NSF-7)	Condensing unit on right
Single, dual or triple faucets	Wine rack
Tower placement (consult factory)	Casters or legs

Consult factory for other model configurations, options and accessories.

* Adding a Riser Base increases overall height 2"

Project Name:

Model Specified:

Location:

Item No:

Quantity:

AIA #:

SIS #:

Standard Model Features

REFRIGERATION SYSTEM

Performance-rated front breathing refrigeration system

Natural, environmentally-safe, high-efficiency R-290 refrigerant¹

Automatic, hot gas condensate evaporator

Extra large, balanced evaporator coil

CABINET ARCHITECTURE

High density, non-CFC polyurethane foamed-in-place insulation

Front, rear and side venting louvered grills

Magnetic snap-in door gaskets

Cylinder-keyed security lock in each door

Stainless steel reinforced threshold

MODEL FEATURES

Low profile cabinet design

Electronic controller w/digital display & hi-low alarm

Continuously cooled, 3" diameter beer column with lever faucet, CO₂ pressure relief distributor and CO₂ tubing with clamps

Easily removable stainless steel drip grate with convenient front-mounted cleanout drainage hose (pan not removable)

Easily accessible and serviceable slide-out condensing unit

¹ R-290 refrigerant meets all federal and state regulatory requirements.

Continental
Refrigerator

Toll-Free: 800-523-7138
Phone: 215-244-1400
Fax: 215-244-9579

539 Dunksferry Road
Bensalem, PA 19020
www.continentalrefrigerator.com

APPROVAL:

Model Specifications

DIMENSIONAL DATA

Net Capacity (cu. ft.)	22 (623 cu l)
Width, Overall (in.)	79 (2007 mm)
Depth, Overall (in.) (incl. handles & bumpers)	25 3/16 (640 mm)
Depth, Body Only (in.) (less doors)	21 (533 mm)
Height, Overall (in.) (not incl. columns)	34 3/4 (883 mm)
Capacity: # Barrel Kegs	3
Capacity: # Straight Wall Kegs	3
Capacity : # 1/6 Size Kegs	12
No. of Doors	3
No. of Beer Columns (with single faucets)	2

REFRIGERANT DATA

Condensing Unit Size (H.P.)	1/3
Capacity (BTU/Hr)*	2500

ELECTRICAL DATA

Voltage (int'l)	115/60/1 (220/50/1)
Feed Wires (incl. ground)	3
Total Amps (int'l)	3.7 (3.4)
10 ft. Cord/Plug [attached] (int'l)	Yes (No)

SHIPPING DATA

Weight (lbs.)	455 (206 kg)
Height - Crated (in.)	46 (1168 mm)
Width - Crated (in.)	88 (2235 mm)
Depth - Crated (in.)	42 (1067 mm)

* Rating @ +25°F evaporator, 90°F ambient
Figures in parentheses reflect metric equivalents rounded to the nearest whole unit.



Equipped with one NEMA-5-15P Plug
(varies by country)

Model Plan Views

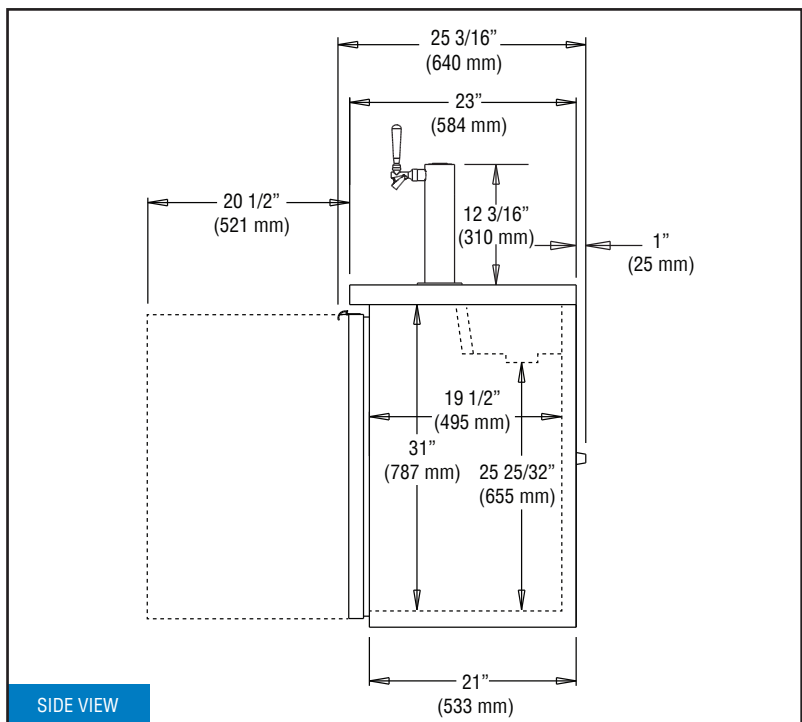
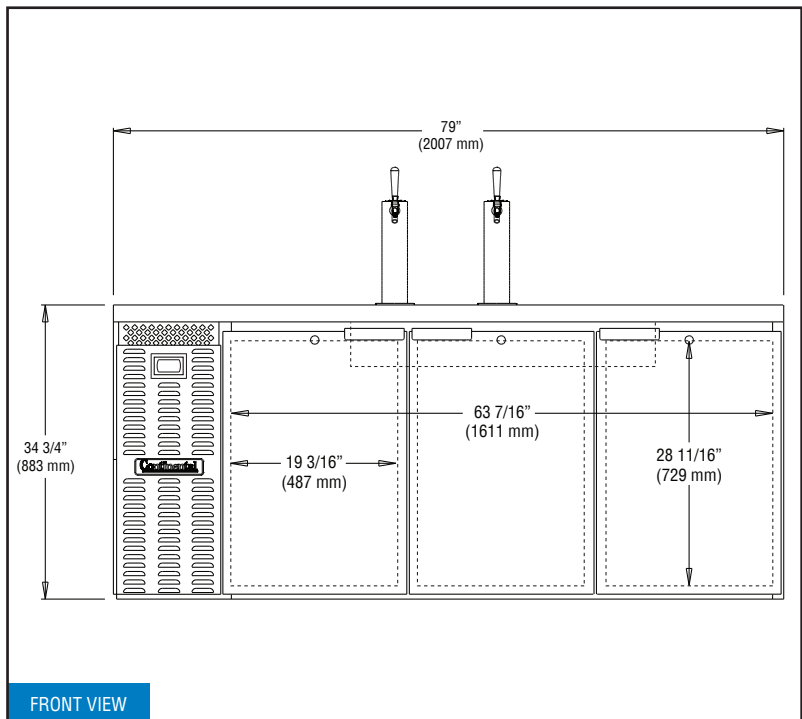

IMPORTANT NOTE: Models are completely front breathing and take in and exhaust air through the front grill. For proper operation, the area in front of the cabinet **must** not be obstructed in any way. A clearance of 1" on the back and 3" on the sides is recommended.

Continental
Refrigerator

Toll-Free: 800-523-7138
Phone: 215-244-1400
Fax: 215-244-9579

539 Dunkserry Road
Bensalem, PA 19020
www.continentalrefrigerator.com

Due to our continued efforts in developing innovative products, specifications subject to change without notice.



Intertek



MADE IN THE U.S.A.

© Copyright 2019, Continental Refrigerator.
A Division of National Refrigeration & Air Conditioning Products, Inc.