



**John  
BOOS**  
Since 1887

ITEM #: \_\_\_\_\_ QTY: \_\_\_\_\_  
 MODEL #: \_\_\_\_\_  
 PROJECT NAME: \_\_\_\_\_

032421

3601 S. Banker St. Effingham, IL 62401 • Ph: (888) 431-2667 • Fax: (800) 433-2667

## **"CB1054" CHEF CUTTING BOARDS**

**1-1/2" THICK - REVERSIBLE**

### **FEATURES:**

- NORTHERN HARD ROCK MAPLE
- EDGE GRAIN CONSTRUCTION
- JUICE GROOVE (ONE SIDE)
- REVERSIBLE WITH RECESSED FINGER GRIPS
- OIL FINISH



CB1054-1M2015150



CB1054-1M2418150

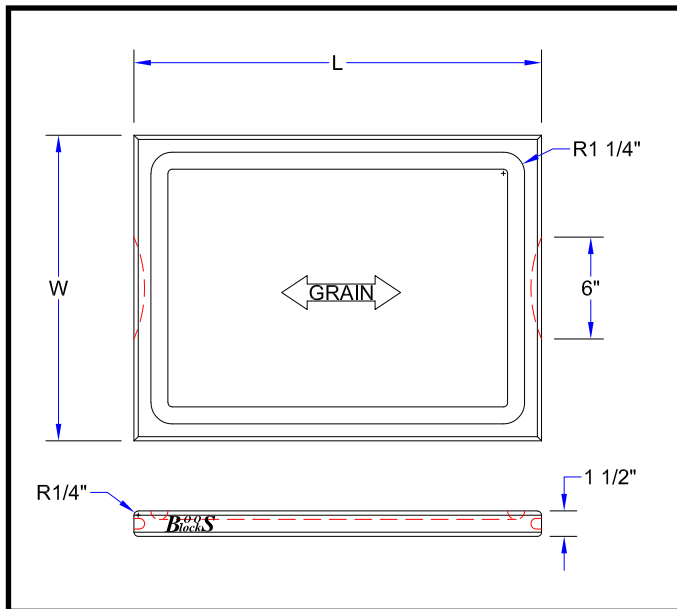

MODEL #	BOARD SIZE (L X W X H)	WT. (LBS)
CB1054-1M2015150	20"X15"X1-1/2"	12
CB1054-1M2418150	24"X18"X1-1/2"	18

SOME UNITS SHIP UNASSEMBLED FOR REDUCED SHIPPING COST. ALL DIMENSIONS ARE TYPICAL. TOLERANCE +/- .500"

John Boos & Co. is constantly engaged in a program of improving products and therefore reserves the right to change specifications without prior notice.



3601 S. Banker St. • Effingham, IL 62401 • quotes@johnboos.com