

# CARTRIDGE, WEQ-10(1.5)5L

Height: 13.12" (33.3cm) Width: 3.57" (9.1cm) Depth: 3.57" (9.1cm)



- Save on maintenance and service costs with a scale control blend that's up to 8 times more scale control capacity, specifically engineered to match the entire chlorine capacity life resulting in reduced scale build-up on evaporator plates and heating coils in both ice machines and coffee brewers
- Designed for low to medium volume applications using a unique blend of catalytic coconut shell carbon rated up to 10,000 gallons to reduce chlorine taste and odor for consistent, great tasting cold and hot beverages, hot water, and ice
- Select filters NSF certified to Standard 42 for reduction of Sediment, Chlorine Taste and Odor and Chloramines
- Certified to NSF Standard 42 for Sediment, Chlorine Taste and Odor reduction

**NOTE:** Do not use with water that is microbiologically unsafe or of unknown quality without adequate disinfection before or after the system.

**Agency:**



Systems and other related parts are certified to NSF International NSF/ANSI Standard 42 and/or NSF International NSF/NANSI Standard 53 as marked.

## Specifications

**Product #:** 56000.0121

**Cartridge Type:** Quick Change

**Application(s):**

**Replacement Cartridge:**

**Filtration Type:**

**Filter Change Frequency:** Every 6 months

## Capacity

Micron Rating	Service Flow Rate	Water Filter Capacity Chlorine Reduction	Water Filter Capacity Chloramine Reduction	Water Filter Capacity Softening
5.0	1.5 gal/min (5.7 L/min)	10000 gal. (37853.4 L)	-	-

## Plumbing Requirements

Inlet Connection	Outlet Connection	Min Operating Pressure	Max Operating Pressure	Min Operating Temperature	Max Operating Temperature
		20 psi (138 kPa)	125 psi (862 kPa)	40°F(4°C)	100°F(38°C)

**WARNING:**



BUNN® reserves the right to change specifications and product design without notice. Such revisions do not entitle the buyer to corresponding changes, improvements, additions or replacements for previously purchased equipment. For most current specifications and other info visit [bunn.com](http://bunn.com).

**Last Updated:**  
02/07/2023

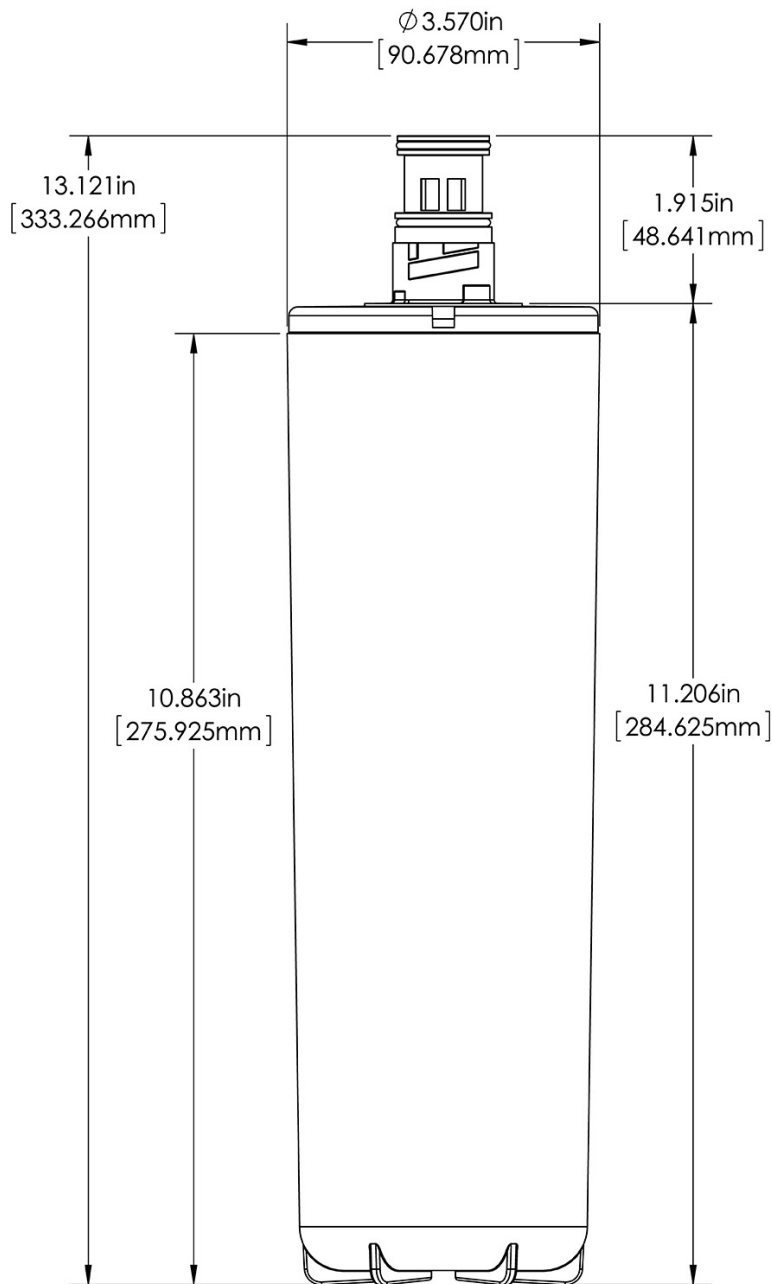

	Dimensions of Filter System <i>(filter head with filter cartridge)</i>			Installed Dimensions <i>(Installation with wall mounting)</i>			Cartridge Dimensions <i>(filter cartridge only)</i>		
	Height	Width	Depth	Height	Width	Depth	Height	Width	Depth
English	-	-	-	-	-	-	13.12 in.	3.57 in.	3.57 in.
Metric	-	-	-	-	-	-	33.3 cm	9.1 cm	9.1 cm

	Weight		Shipping				
	Dry	Wet	Height	Width	Depth	Weight	Volume
English	0.0 lbs	0.0 lbs	6.00 in.	6.00 in.	16.50 in.	4.000 lbs	-
Metric	-	-	15.2 cm	15.2 cm	41.9 cm	1.814 kgs	-

**WARRANTY:** BUNN High Performance Water Filtration Solutions Systems by BUNN® (excluding water filters and water treatment replacement cartridges) are covered by a limited warranty against defects in material and workmanship for a period of five years after date of purchase, under normal use and service, and when installed in accordance with manufacturer's recommendations outlined in the filtration systems owner's manual. BUNN replaceable elements (water treatment cartridges, filter elements, and feeder elements) are covered by a limited warranty against defects in material and workmanship for a period of one year after date of purchase or the remainder of the original warranty, whichever is longer. See printed warranty for full details. BUNN will provide a copy of the warranty upon request.



BUNN® reserves the right to change specifications and product design without notice. Such revisions do not entitle the buyer to corresponding changes, improvements, additions or replacements for previously purchased equipment. For most current specifications and other info visit [bunn.com](http://bunn.com).

Last Updated:  
02/07/2023



SYSTEM, WEQ-10(1.5)5L

Product #: 56000.0024



HEAD ASSEMBLY, WEQ-SINGLE

Product #: 56000.0201

# Model Compatibility: CARTRIDGE, WEQ-10(1.5)5L(56000.0121)

\*Serving and Holding selections are currently unavailable. Please contact your sales representative to find out more information.\*



BUNN® reserves the right to change specifications and product design without notice. Such revisions do not entitle the buyer to corresponding changes, improvements, additions or replacements for previously purchased equipment. For most current specifications and other info visit [bunn.com](http://bunn.com).

Last Updated:  
02/07/2023